

High Power relay 50 A



Power generators



Back-up generators



Pump control



Disabled lift



Inverter



Printed circuit mount - 3 mm contact gap
50 A Power relay for photovoltaic inverters

Type 67.22-x300
- 2 NO

Type 67.23-x300
- 3 NO

- Contact gap ≥ 3 mm (according to VDE 0126-1-1, EN 62109-1, EN 62109-2)
- DC coils, with only 170 mW holding power
- Reinforced insulation between coil and contacts
- 1.5 mm gap between PCB and relay base
- Suitable for use at ambient temperatures up to 85 °C (with energy-saving coil energization) or 70 °C (with standard coil energization)
- Meets the EN 60335-1 requirements of resistance to heat and fire (GWIT 775 °C and GWFI 850 °C)
- Cadmium free contact materials:
 - AgNi version (for applications where lower contact resistance is needed)
 - AgSnO₂ version (for applications where higher inrush current values are expected)

For outline drawing see page 8

Contact specification

Contact configuration		2 NO (DPST-NO)	3 NO (3PST-NO)
Contact gap	mm	≥ 3	≥ 3
Rated current/ Maximum peak current (for 5 ms)	A	50/150	50/150
Rated voltage/ Maximum switching voltage	V AC	400/690	400/690
Rated load AC1/AC7a (per pole)	VA	20000	20000
Rated load AC15 (per pole @ 230 V AC)	VA	2300	2300
Single-phase motor rating (230 V AC)	kW	2.2	2.2
Three-phase motor rating (480 V AC)	kW	—	11
Breaking capacity DC1: 24/110/220 V	A	50/4/1	50/4/1
Minimum switching load	mW (V/mA)	1000 (10/10)	1000 (10/10)
Standard contact material		AgSnO ₂	AgSnO ₂

Coil specification

Nominal voltage (U _N)	V DC	5 - 6 - 8 - 12 - 24 - 48 - 60 - 110	
Rated power	W	1.7	1.7
Operating range (-40...+70)°C	DC	(0.90 ... 1.1)U _N	(0.90 ... 1.1)U _N
Energy-saving mode (-40...+85)°C			
Operating range for 1 s		(0.95...2.5)U _N	(0.95...2.5)U _N
Holding voltage range	DC	(0.32...0.65)U _N	(0.32...0.65)U _N
Minimum holding power	W	0.17	0.17
Must drop-out voltage	DC	0.05 U _N	0.05 U _N

Technical data

Mechanical life	cycles	1 · 10 ⁶	1 · 10 ⁶
Electrical life at rated load AC7a	cycles	30 · 10 ³	30 · 10 ³
Operate/release time	ms	25/5	25/5
Ambient temperature range (energy-saving mode)	°C	-40...+70 (-40...+85)	-40...+70 (-40...+85)
Environmental protection		RT II	RT II

Approvals (according to type)



67.22-x300



- 2 NO
- Contact gap ≥ 3 mm
- PCB mount

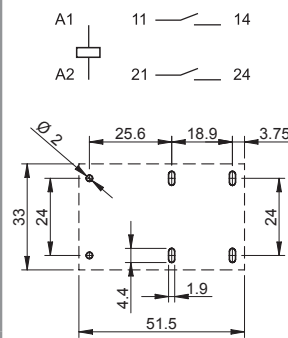

Copper side view

67.23-x300



- 3 NO
- Contact gap ≥ 3 mm
- PCB mount

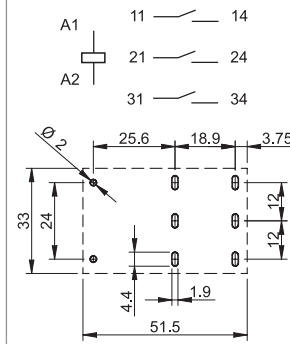

Copper side view

**Printed circuit mount - 5.2 mm contact gap
50 A Power relay for photovoltaic inverters**
Type 67.22-x500

- 2 NO

Type 67.23-x500

- 3 NO

- Contact gap ≥ 5.2 mm (according to VDE 0126-1-1, EN 62109-1, EN 62109-2)
- Suitable for inverters with DC input up to 1500 V and AC output up to 690 V, installations up to 4000 m above sea level
- DC coils, with only 170 mW holding power
- Reinforced insulation between coil and contacts
- 1.5 mm gap between PCB and relay base
- Suitable for use at ambient temperatures up to 85 °C (with energy-saving coil energization) or 60 °C (with standard coil energization)
- Meets the EN 60335-1 requirements of resistance to heat and fire (GWIT 775 °C and GWFI 850 °C)
- Cadmium free contact materials:
 - AgNi version (for applications where lower contact resistance is needed)
 - AgSnO₂ version (for applications where higher inrush current values are expected)

For outline drawing see page 8

Contact specification

Contact configuration

67.22-x500

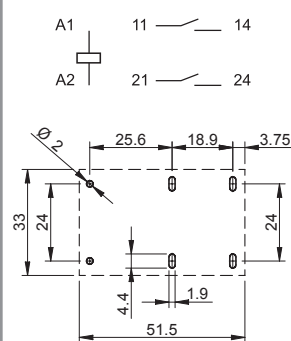

- 2 NO
- Contact gap ≥ 5.2 mm
- PCB mount



Copper side view

67.23-x500

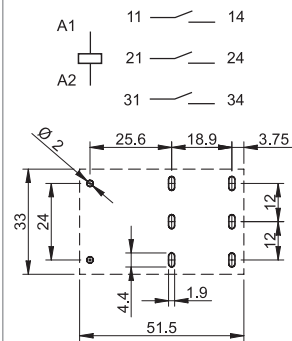
- 3 NO
- Contact gap ≥ 5.2 mm
- PCB mount



Copper side view

Contact gap

mm

 ≥ 5.2
 ≥ 5.2

 Rated current/
Maximum peak current (for 5 ms)

A

50/150

50/150

 Rated voltage/
Maximum switching voltage

V AC

400/690

400/690

Rated load AC1/AC7a (per pole)

VA

20000

20000

Rated load AC15 (per pole @ 230 V AC)

VA

2300

2300

Single-phase motor rating (230 V AC)

kW

2.2

2.2

Three-phase motor rating (480 V AC)

kW

—

11

Breaking capacity DC1: 24/110/220

A

50/7/2

50/7/2

Minimum switching load

mW (V/mA)

1000 (10/10)

1000 (10/10)

Standard contact material

 AgSnO₂

 AgSnO₂
Coil specification

 Nominal voltage (U_N)

V DC

5 - 6 - 8 - 12 - 24 - 48 - 60 - 110

Rated power

W

2.7

2.7

Operating range (-40...+60)°C

DC

 (0.90 ... 1.1)U_N

 (0.90 ... 1.1)U_N

Energy-saving mode (-40...+85)°C

Operating range for 1 s

 (0.95...2.5)U_N

 (0.95...2.5)U_N

Holding voltage range

DC

 (0.25...0.5)U_N

 (0.25...0.5)U_N

Minimum holding power

W

0.17

0.17

Must drop-out voltage

DC

 0.05 U_N

 0.05 U_N
Technical data

Mechanical life

cycles

 1 · 10⁶

 1 · 10⁶

Electrical life at rated load AC7a

cycles

 30 · 10³

 30 · 10³

Operate/release time

ms

30/4

30/4

 Ambient temperature range
(energy-saving mode)

°C

-40...+60 (-40...+85)

-40...+60 (-40...+85)

Environmental protection

RT II

RT II

Approvals (according to type)

Ordering information

Example: 67 series solar relay, single PCB terminals, 2 pole NO, ≥ 3 mm contact gap.

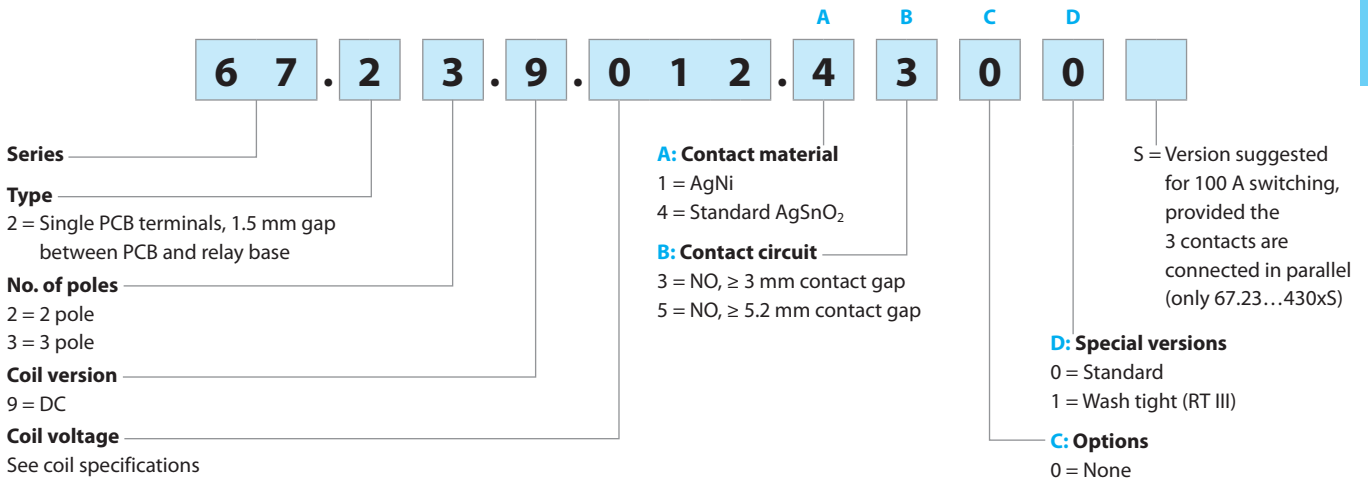

Technical data

Insulation according to EN 61810-1				
Nominal voltage of supply system	V AC	400/690 3-phase	400 1-phase	230/400
Rated insulation voltage	V AC	630	400	400
Pollution degree		3		
Insulation between coil and contact set				
Type of Insulation		Reinforced		
Overvoltage category		III		
Rated impulse voltage	kV (1.2/50 μs)	6		
Dielectric strength	V AC	4000		
Insulation between adjacent contacts				
Type of Insulation		Basic		
Overvoltage category		III		
Rated impulse voltage	kV (1.2/50)μs	6		
Dielectric strength	V AC	2500		
Insulation between open contacts				
Type of disconnection		Micro-disconnection*		Full-disconnection
Overvoltage category		—		III
Rated impulse voltage	kV (1.2/50)μs	—		4
Dielectric strength	V AC	2500 (67.xx-x300)/3000 (67.xx-x500)		
Insulation between coil terminals				
Rated impulse voltage (surge) differential mode (according to EN 61000-4-5)	kV(1.2/50 μs)	4		
Other data				
Bounce time: NO	ms	2		
Vibration resistance (10...150)Hz: NO	g	15		
Shock resistance	g	35		
Power lost to the environment	without contact current	W	1.7 (67.xx-x300)/2.7 (67.xx-x500)	
	with rated current	W	8.5 (67.xx-x300)/9.5 (67.xx-x500)	
Recommended distance between relays mounted on PCB	mm	≥ 20		
Short circuit protection				
Rated conditional short circuit current	kA	5		
Back-up fuse for motor load	A	30 (delayed type)		

* with overvoltage category II: Full-disconnection

Contact specification

F 67 - Electrical life v contact current (AC1/AC7a load)

A

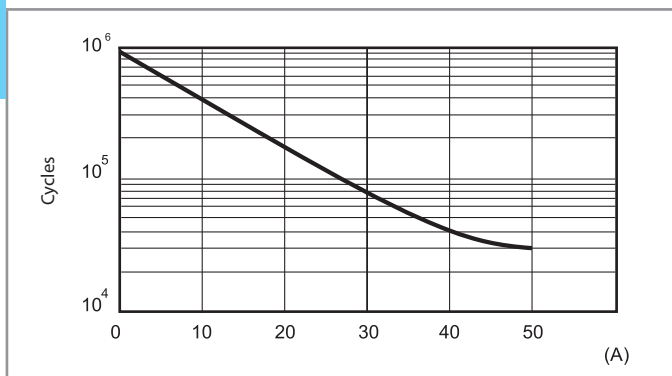

H 67 - Maximum DC breaking capacity (67.xx-x300)

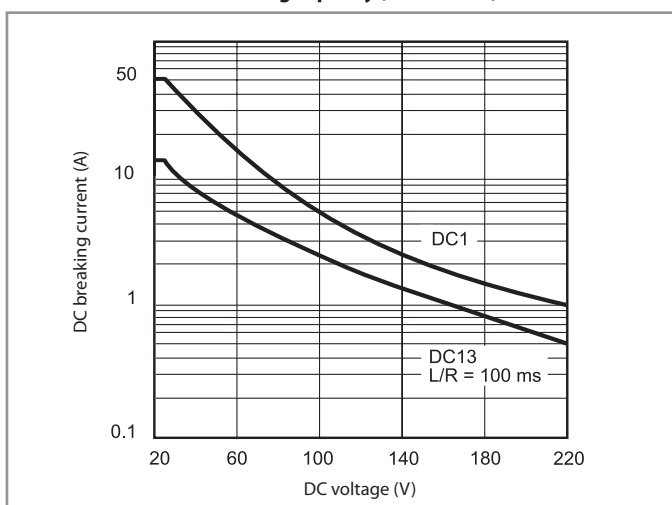

When switching a resistive (DC1) or inductive (DC13) load having voltage and current values under the corresponding curve, an electrical life of > 30000 cycles can be expected.

H 67 - Maximum DC breaking capacity (67.xx-x500)

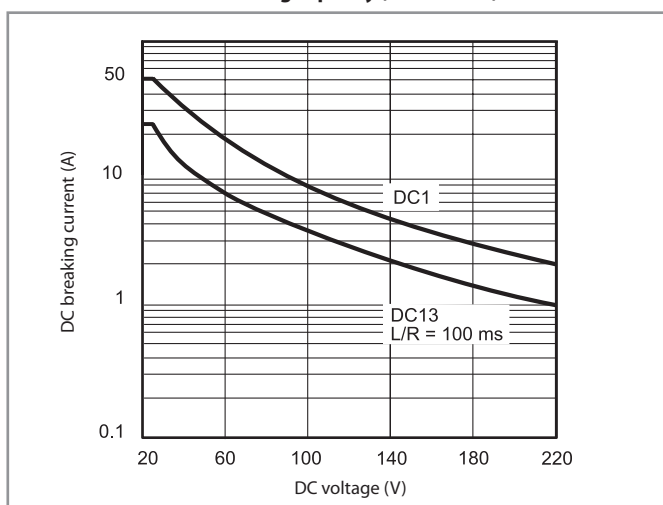

When switching a resistive (DC1) or inductive (DC13) load having voltage and current values under the corresponding curve, an electrical life of > 30000 cycles can be expected.

Connection of contacts in parallel

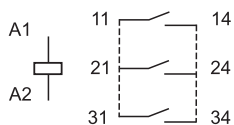

Connecting in parallel the contacts, with appropriate dimensioning of tracks on PC board, allow the relays to carry and switch loads up to 100 A:
 - 100 A, with 67.23...4300S version
 - 80 A, with 67.23...1300 version

Coil specifications

DC coil data, 67.xx-x300

Nominal voltage U_N	Coil code	Operating range (@ 70 °C max)		Holding voltage U_h	Resistance R	Rated coil consumption I at U_N I_N
		U_{min}	U_{max}			
V		V	V	V	Ω	mA
5	9.005	4.5	5.5	1.6	14.7	340
6	9.006	5.4	6.6	1.9	21.5	279
8	9.008	7.2	8.8	2.6	37.6	213
12	9.012	10.8	13.2	3.8	85	141
24	9.024	21.6	26.4	7.7	340	71
48	9.048	43.2	52.8	15.4	1355	35
60	9.060	54	66	19.2	2120	28
110	9.110	99	121	35.2	7120	15

DC coil data, 67.xx-x500

Nominal voltage U_N	Coil code	Operating range (@ 60 °C max)		Holding voltage U_h	Resistance R	Rated coil consumption I at U_N I_N
		U_{min}	U_{max}			
V		V	V	V	Ω	mA
5	9.005	4.5	5.5	1.25	9.3	538
6	9.006	5.4	6.6	1.5	13.5	444
8	9.008	7.2	8.8	2	23.7	338
12	9.012	10.8	13.2	3	53.5	224
24	9.024	21.6	26.4	6	213	113
48	9.048	43.2	52.8	12	855	56
60	9.060	54	66	15	1335	45
110	9.110	99	121	27.5	4500	24

R 67 - Operating range v ambient temperature, 67.xx-x300
with standard (continuous) coil energization (-40...+70)°C

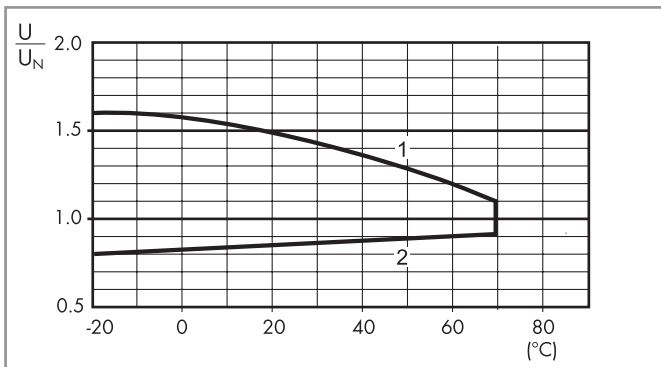

- 1 - Max. permitted coil voltage.
- 2 - Min. pick-up voltage with coil at ambient temperature.

Energy saving mode

In some applications, such as photovoltaic inverters, it may be necessary to minimize the overall relay power dissipation and to permit use at higher ambient temperature levels (up to 85 °C). This can be achieved by initially applying a coil voltage within the Energy saving mode Operating range (see diagram to the right) and then rapidly (< 1 s) reducing the coil voltage to a level within the Holding voltage range. The lower the Holding voltage, the lower is the continuous power dissipation of the coil (0.17 W minimum).

Coil voltages as high as 2.5 U_N may be used, when necessary, to reduce the contact operate time.

R 67 - Operating range v ambient temperature, 67.xx-x500
with standard (continuous) coil energization (-40...+60)°C

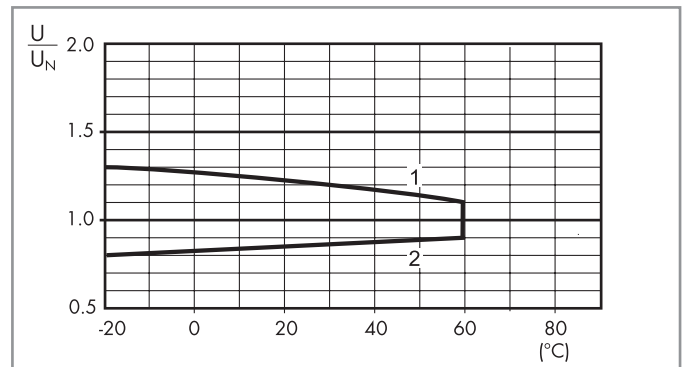

- 1 - Max. permitted coil voltage.
- 2 - Min. pick-up voltage with coil at ambient temperature.

R 67 - Operating range v ambient temperature, 67.xx-x300/x500
in energy saving mode (-40...+85)°C

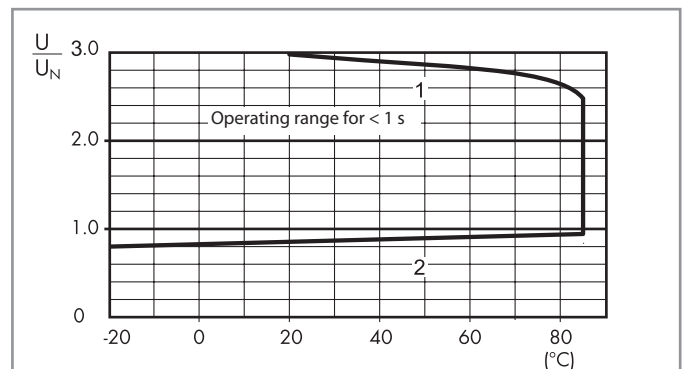

- 1 - Max. permitted coil voltage.
- 2 - Min. pick-up voltage with coil at ambient temperature.

Outline drawings

A

Type 67.22

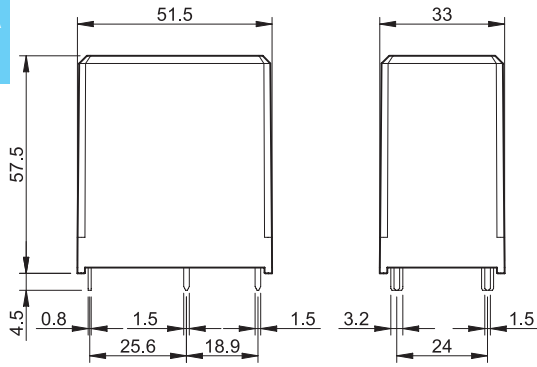

Type 67.23

